

Varistors

GENERAL

Varistors provide reliable and economical protection against high voltage transients and surges which may be produced, for example, by lightning, switching or electrical noise on AC or DC power lines. They have the advantage over transient suppressor diodes in as much as they can absorb much higher transient energies and can suppress positive and negative transients.

When a transient occurs, the varistor resistance changes from a very high stand-by value to a very low conducting value. The transient is thus absorbed and clamped to a safe level, protecting sensitive circuit components.

Varistors are manufactured from a non-homogeneous material, giving a rectifying action at the contact points of two particles. Many series and parallel connections determine the voltage rating and the current capability of the varistor.

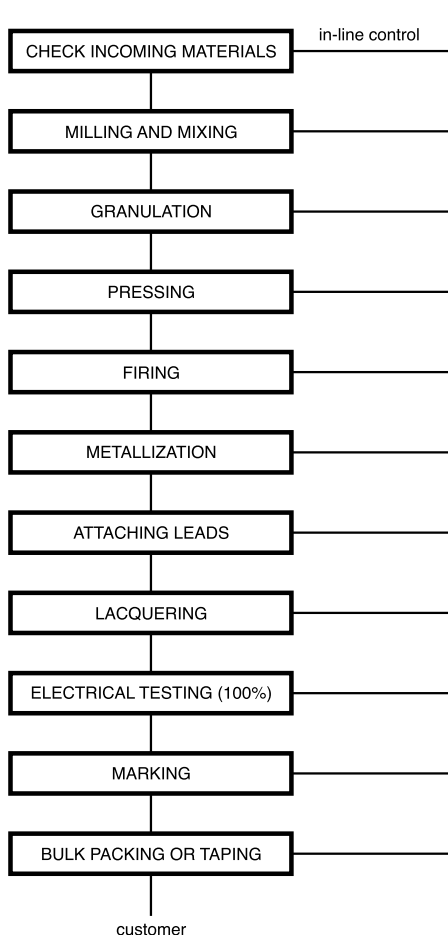

Manufacturing process flow chart

FEATURES

- Wide voltage range selection - from 14 V_{RMS} to 680 V_{RMS} . This allows easy selection of the correct component for the specific application.
- High energy absorption capability with respect to size of component.
- Response time of less than 20 ns, clamping the transient the instant it occurs.
- Low stand-by power - virtually no current is used in the stand-by condition.
- Low capacitance values, making the varistors suitable for the protection of digital switching circuitry.
- High body insulation - an ochre coating provides protection up to 2500 V, preventing short circuits to adjacent components or tracks.
- Available on tape with accurately defined dimensional tolerances, making the varistors ideal for automatic insertion.
- Approved to UL 1449 edition 3 (file number: E332800) and manufactured using UL approved flame retardant materials.
- Completely non flammable, in accordance with IEC, even under severe loading conditions.
- Non porous lacquer making the varistors safe for use in humid or toxic environments. The lacquer is also resistant to cleaning solvents in accordance with IEC 60068-2-45.

VARISTOR MANUFACTURING PROCESS

In order to guarantee top performance and maximum reliability, close in-line control is maintained over the automated manufacturing techniques. The manufacturing process flow chart shows each step of the manufacturing process, clearly indicating the emphasis on in-line control.

Each major step in the manufacturing process shown in the Manufacturing process flow chart is described in the following sections:

MILLING AND MIXING

Incoming materials are checked, weighed, milled and mixed for several hours to make a homogeneous mixture.

GRANULATION

A binder is added to produce larger granules for processing.

PRESSING

The surface area and thickness of the disc help to determine the final electrical characteristics of the varistor, therefore pressing is a very important stage in the manufacturing process. The granulated powder is fed into dies and formed into discs using a high speed rotary press.

FIRING

The pressed products are first pre-fired to burn out the binder. They are then fired for a controlled period and temperature until the required electrical characteristics are obtained. Regular visual and electrical checks are made on the fired batch.

METALLIZATION

The fired ceramic discs are metallized on both sides with a silver content layer to produce good low resistive electrical contacts. Metallization is achieved by screen printing. Visual checks are made regularly and a solderability test is carried out in each production batch.

ATTACHING LEADS

Leads are automatically soldered to the metallized faces and regular strength tests are made. Three types of lead configuration are available; one with straight leads, one with straight leads and flange, and one with kinked leads.

LACQUERING

The components are coated by immersing them in a special non flammable ochre epoxy lacquer. Two coats are applied and the lacquer is cured. Regular tests to check the coating thickness are made.

ELECTRICAL TESTING (100 %)

The voltage of each component is normally checked at two reference currents (1 mA and another according to the application). Any rejects are automatically separated for further evaluation.

MARKING

All components are laser marked with type identification, voltage rating and date code.

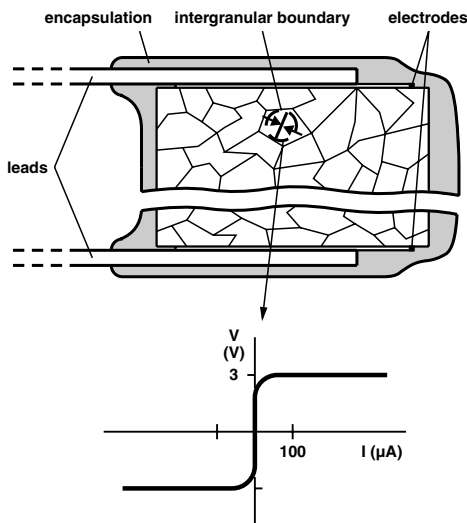

QUALITY

APPROVALS

- UL 1449 ed. 3 according file E332800
- VDE following IEC 61051-1/2 according file 40002622 or 40013495
- CSA file 219883 and cUL accoring file E332800

The term 'QUALITY ASSESSMENT' is defined as the continuous surveillance by the manufacturer of a product to ensure that it conforms to the requirements to which it was made.

PRODUCT AND PROCESS RELEASE

Recognized reliability criteria are designed into each new product and process from the beginning. Evaluation goes far beyond target specifications and heavy emphasis is placed upon reliability. Before production release, new varistors must successfully complete an extended series of life tests under extreme conditions.

MONITORING INCOMING MATERIALS

Apart from carrying out physical and chemical checks on incoming raw materials, a very close liaison with material suppliers is maintained. Incoming inspection and product results are gradually fed back to them, so ensuring that they also maintain the highest quality standards.

IN-LINE CONTROL

The manufacturing centre operates in accordance with the requirements of IEC 61051-1 and UL 1449. Each operator is actively engaged in quality checking. In addition, in-line inspectors and manufacturing operators make regulated spot checks as a part of our Statistical Process Control (SPC).

FINAL INSPECTION AND TEST (100 %)

At the end of production, each varistor is inspected and tested prior to packing.

LOT TESTING

Before any lot is released, it undergoes a series of special lot tests under the supervision of the Quality department.

PERIODIC SAMPLE TESTING

Component samples are periodically sent to the Quality laboratory for rigorous climatic and endurance tests to IEC/UL requirements. Data from these tests provide a valuable means of exposing long term trends that might otherwise pass unnoticed. The results of these tests are further used to improve the production process.

FIELD INFORMATION

The most accurate method of assessing quality is monitoring performances of the devices in the field. Customer feedback is actively encouraged and the information is used to study how the components may be further improved. This close relationship with customers is based on mutual trust built up over many years of co-operation.

DEFINITIONS

MAXIMUM CONTINUOUS VOLTAGE

The maximum voltage which may be applied continuously between the terminals of the component. For all types of AC voltages, the voltage level determination is given by the crest voltage $\times 0.707$.

VOLTAGE AT 1 mA OR VARISTOR VOLTAGE

The voltage across a varistor when a current of 1 mA is passed through the component. The measurement shall be made in as short a time as possible to avoid heat perturbation.

The varistor voltage is essentially a point on the V/I characteristic permitting easy comparison between models and types.

MAXIMUM CLAMPING VOLTAGE

The maximum voltage between two terminals when a standard pulse current of rise time 8 μs and decreasing time 20 μs (8 μs to 20 μs) is applied through the varistor in accordance with IEC 60060-2, section 6.

The specified current for this measurement is the class current.

MAXIMUM NON REPETITIVE SURGE CURRENT

The maximum peak current allowable through the varistor is dependent on pulse shape, duty cycle and number of pulses. In order to characterize the ability of the varistor to withstand pulse currents, it is generally allowed to warrant a 'maximum non repetitive surge current'. This is given for one pulse characterized by the shape of the pulse current of 8 μs to 20 μs following IEC 60060-2, with such an amplitude that the varistor voltage measured at 1 mA does not change by more than 10 % maximum.

A surge in excess of the specified withstanding surge current may cause short circuits or package rupture with expulsion of material; it is therefore recommended that a fuse be put in the circuit using the varistor, or the varistor be used in a protective box

If more than one pulse is applied or when the pulse is of a longer duration, derating curves are applied (see relevant information in the data sheet); these curves guarantee a maximum varistor voltage change of $\pm 10\%$ at 1 mA.

MAXIMUM ENERGY

During the application of one pulse of current, a certain energy will be dissipated by the varistor. The quantity of dissipation energy is a function of:

- The amplitude of the current
- The voltage corresponding to the peak current
- The rise time of the pulse
- The decrease time of the pulse; most of the energy is dissipated during the time between 100 % and 50 % of the peak current

- The non-linearity of the varistor

In order to calculate the energy dissipated during a pulse, reference is generally made to a standardized wave of current. The wave prescribed by IEC 60060-2 section 6 has a shape which increases from zero to a peak value in a short time, and thereafter decreases to zero either at an approximate exponential rate, or in the manner of a heavily damped sinusoidal curve. This curve is defined by the virtual lead time (t_1) and the virtual time to half value (t_2) as shown in the maximum energy curve (page 5).

The calculation of energy during application of such a pulse is given by the formula: $E = (V_{\text{peak}} \times I_{\text{peak}}) \times t_2 \times K$

where:

I_{peak} = peak current

V_{peak} = voltage at peak current

β = given for $I = \frac{1}{2} \times I_{\text{peak}}$ to I_{peak}

K is a constant depending on t_2 , when t_1 is 8 μs to 10 μs (see table on page 8).

A low value of β corresponds to a low value of V_{peak} and then to a low value of E.

The maximum energy published does not represent the quality of the varistor, but can be a valuable indication when comparing the various series of components which have the same varistor voltage. The maximum energy published is valid for a standard pulse of duration 10 μs to 1000 μs giving a maximum varistor voltage change of $\pm 10\%$ at 1 mA

When more than one pulse is applied, the duty cycle must be so that the rated average dissipation is not exceeded. Values of the rated dissipation are:

0.1 W for series 2381 592/582

0.25 W for series 2381 593/583

0.4 W for series 2381 594/584

0.6 W for series 2381 595/585

1 W for series 2381 596/586

ELECTRICAL CHARACTERISTICS

Typical V/I characteristic of a ZnO varistor

The relationship between voltage and current of a varistor can be approximated to: $V = C \times I^\beta$

where:

V = voltage

C = varistor voltage at 1 A

I = actual working current

β = tangent of angle curve deviating from the horizontal

Examples

When:

$C = 230 \text{ V at } 1 \text{ A}$

$\beta = 0.035 \text{ (ZnO)}$

$I = 10^{-3} \text{ A or } 10^2 \text{ A}$

$V = C \times I^\beta$

so that for current of 10^{-3} A : $V = 230 \times (10^{-3})^{0.035} = 180 \text{ V}$ and for a current of 10^2 A : $V = 230 \times (10^2)^{0.035} = 270 \text{ V}$

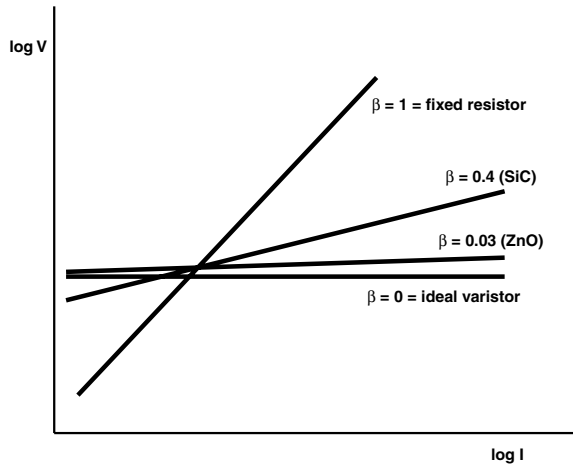

Varistor characteristics using different β values

SPECIFICATION OF A VARISTOR CURVE

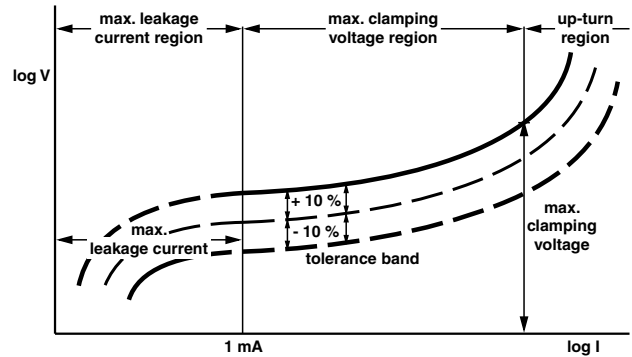

Working points on a varistor curve

The drawing below shows the various working points on the varistor curve using the series 2381 593 60 V type as an example. The electrical characteristic values are shown in the Electrical Characteristics table below.

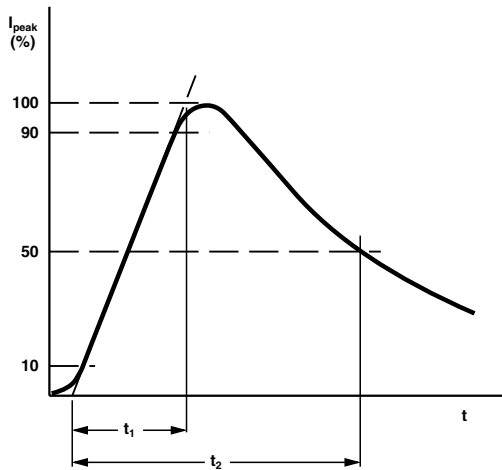

Maximum energy curve

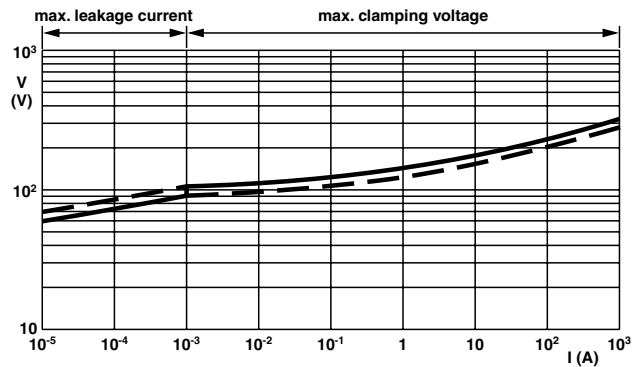

Curve for varistor type 2381 593 .606

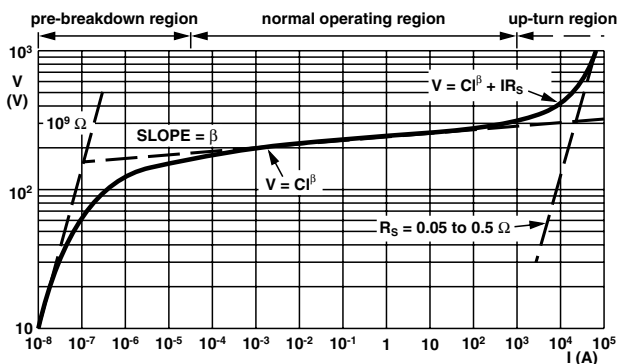

Typical V/I curve

Pre-breakdown region: $V \approx \infty I$; highly temperature dependent

Normal operating region: $V = C \times I^\beta$

Up-turn region: $V = C \times I^\beta + I \times R_s$

ELECTRICAL CHARACTERISTICS

PARAMETER	VALUE
Maximum RMS voltage	60 V
Maximum DC working voltage	$\sqrt{2} \times 60 \text{ V} = 85 \text{ V}$
Varistor voltage	$100 \text{ V} \pm 10 \%$
Maximum clamping voltage at 10 A	165 V
Maximum non-repetitive current	1200 A
Leakage current at 85 V _{DC}	$10^{-5} \text{ A to } 5 \times 10^{-4} \text{ A}$
Transient energy	$10 \mu\text{s to } 1000 \mu\text{s: } 8.3 \text{ J}$

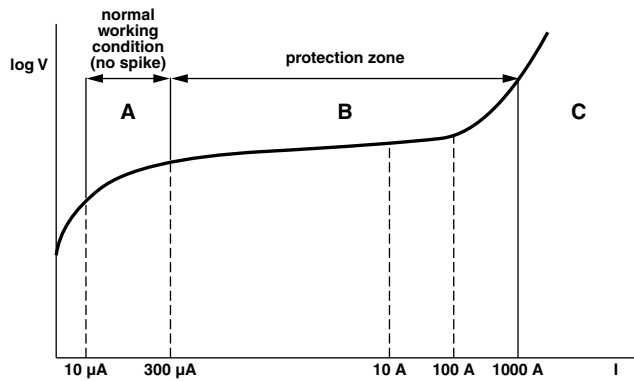

Definitions of the varistor curve

The points A, B and C shown on the curve are defined in the Varistor Curve Definitions table.

VARISTOR CURVE DEFINITIONS	
POINT	DESCRIPTION
A	Normal working zone: current is kept as low as possible in order to have low dissipation during continuous operation (between 10 μA to 300 μA).
B	Maximum clamping voltage: the maximum voltage for a given (class) current (peak current based upon statistical probability determined by standardization authorities).
C	Maximum withstanding surge current: the maximum peak current that the varistor can withstand (only) once in its lifetime.

TRANSIENT VOLTAGE LIMITATION WITH ZnO VARISTORS

Principles of voltage limitation

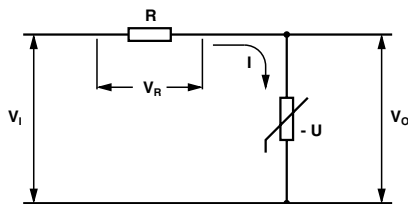

Voltage limitation using a varistor

In the Voltage limitation using a varistor drawing above, the supply voltage V_1 is derived by the resistance R (e.g. the line resistance) and the varistor ($-U$) selected for the application.

$$V_1 = V_R + V_O$$

$$V_1 = R \times I + C \times I^\beta$$

If the supply voltage varies by an amount ΔV_1 the current variation is ΔI and the supply voltage may be expressed as:

$$(V_1 + \Delta V_1) = R (I + \Delta I) + C (I + \Delta I)^\beta$$

Given the small value of β (0.03 to 0.05), it is evident that the modification of $C \times I^\beta$ will be very small compared to the variation of $R \times I$ when V_1 is increased to $V_1 + \Delta V_1$.

A large increase of V_1 will induce a large increase of V_R and a small increase of V_O .

Examples

The varistor is a typical component of the series 2381 592 52716 ($C = 520$; $\beta = 0.04$) and $R = 250 \Omega$.

For $V_1 = 315 \text{ V}$ (crest voltage of the 220 V supply voltage):
 $I = 10^{-5} \text{ A}$, $V_R = 2.5 \times 10^{-3} \text{ V}$ and $V_O = 315 \text{ V}$

For $V_1 = 500 \text{ V}$: $I = 10^{-1} \text{ A}$, $V_R = 25 \text{ V}$ and $V_O = 475 \text{ V}$

For $V_1 = 1000 \text{ V}$: $I = 1.88 \text{ A}$, $V_R = 470 \text{ V}$ and $V_O = 530 \text{ V}$

The influence of a series resistance on the varistor drawing shows the influence of different values of series resistors on the varistor efficiency.

By drawing the load line, it is also possible to estimate the variation of the voltages V_R and V_O when V_1 is increased to 500 V or 1000 V. This effect is shown in the graphs below.

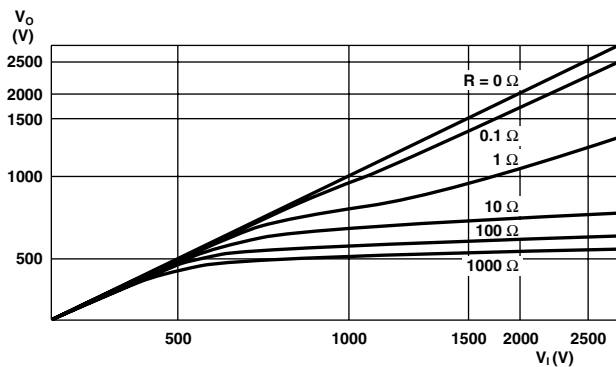

Influence of a series resistance on the varistor

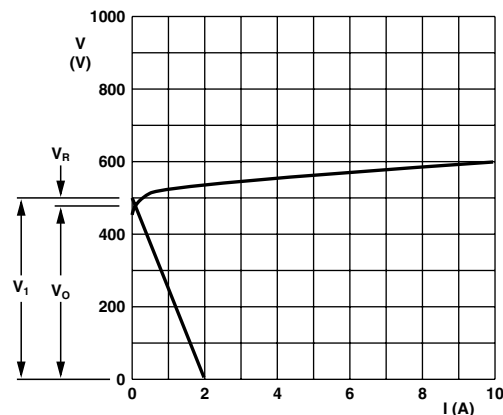

Influence on varistor when V_1 is 500 V ($R = 250 \Omega$)

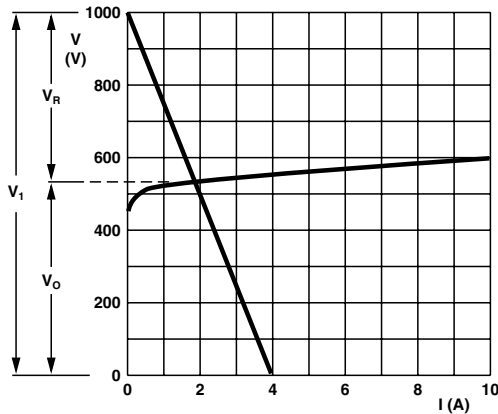

Influence on varistor when V_1 is 1000 V ($R = 250 \Omega$)

EQUIVALENT CIRCUIT MODEL

A simple equivalent circuit representing a metal oxide varistor as a capacitance in parallel with a voltage dependent resistor is shown in the Equivalent circuit model drawing. C_p and R_p are the capacitance and resistance of the intergranular layer respectively; R_g is the ZnO grain resistance. For low values of applied voltages, R_p behaves as an ohmic loss.

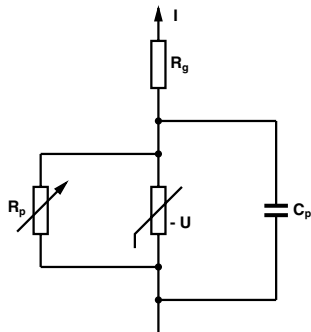

Equivalent circuit model

CAPACITANCE

Depending on area and thickness of the device, the capacitance of the varistor increases with the diameter of the disc, and decreases with its thickness.

In DC circuits, the capacitance of the varistor remains approximately constant provided the applied voltage does not rise to the conduction zone, and drops abruptly near the rated maximum continuous DC voltage.

In AC circuits, the capacitance can affect the parallel resistance in the leakage region of the V/I characteristic. The relationship is approximately linear with the frequency and the resulting parallel resistance can be calculated from $1/\omega C$ as for a usual capacitor.

Nevertheless, due to the structural characteristic of the zinc oxide varistors, the capacitance itself decreases slightly with an increase in frequency. This phenomenon is emphasized when the frequency reaches approximately 100 kHz. See the effect of HF alternating current on the varistor type 2381 595 52516; $C = 480 \text{ pF}$ drawing.

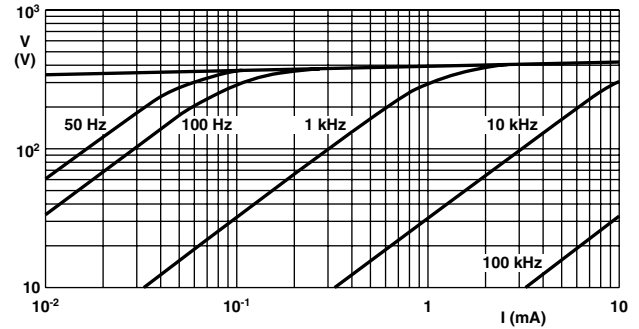

Effect of HF alternating current on varistor type 2381 595 52516; $C = 480 \text{ pF}$

ENERGY HANDLING

Maximum allowable peak current and maximum allowable energy are standardized using defined pulses:

- Peak current (A); 8 μs to 20 μs , 1 pulse
- Energy (J); 10 μs to 1000 μs , 1 pulse

INTERNATIONALLY ACCEPTED PULSES

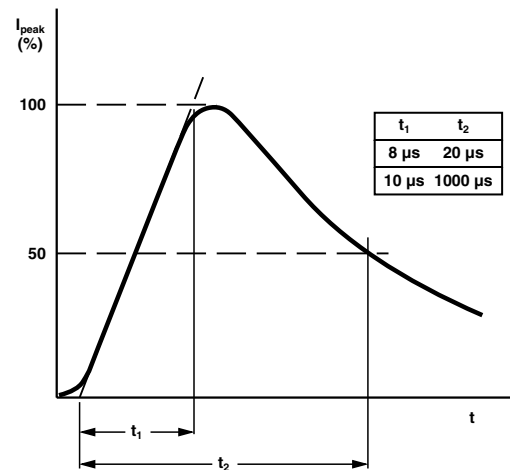

Standard pulse for current and maximum allowable energy calculation

Examples

Pulse life time rating of 2381 593, 60 V type.

Energy capability: $E = K \times V_p \times I_p \times t_2$

1 pulse; 8 μs to 20 μs : 1200 A = 1 x 8 J

10 pulses; 8 μs to 20 μs : 300 A = 10 x 1.45 J

1 pulse; 10 μs to 1000 μs : 33A = 1 x 8.3 J

10 pulses; 10 μs to 1000 μs : 11 A = 10 x 2.5 J

The maximum specified energy is defined for a maximum shift ($\Delta V/V$) 1 mA \leq 10 %:

I_p = pulse current

V_p = corresponding clamping voltage

K DEPENDS ON T2 WHEN T1 IS 8 μs TO 10 μs	
t_2 (μs)	K
20	1
50	1.2
100	1.3
1000	1.4

Typical surge life rating curves (number of surges allowed as a function of pulse time and maximum current) are shown in drawing below.

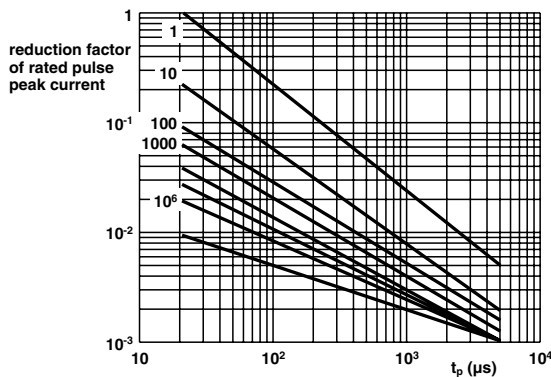

Maximum peak current for various number of pulses as a function of pulse duration

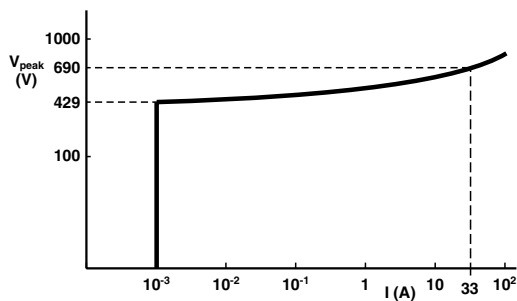

$$E = K \times V_{\text{peak}} \times I_{\text{peak}} \times t_2 = 1.4 \times 700 \times 33 \times 10^{-3} = 32 \text{ J}$$

Example of calculation of energy for a 2381 593 52516 type, at the maximum peak current (33 A) for a duration $t_2 = 1000 \mu\text{s}$ ($K = 1.4$)

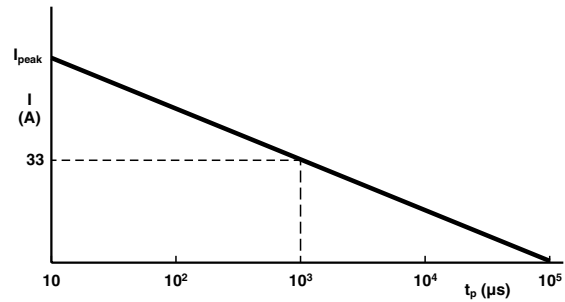

Maximum energy (10 x 1000 μs): 1 pulse

Example: 2381 593 52516 (250 V)

Example of selection of the maximum peak current as a function of pulse duration.

DISSIPATED POWER

DC DISSIPATION

The power dissipated in a varistor is equal to the product of the voltage and current, and may be written:

$$W = I \times V = C \times I^{\beta+1} \text{ or } K \times V^{\alpha+1}$$

When the coefficient $\alpha = 30$ ($\beta = 0.033$), the power dissipated by the varistor is proportional to the 31st power of the voltage. A voltage increase of only 2.26 % will, in this case, double the dissipated power. Consequently, it is very important that the applied voltage does not rise above a certain maximum value, or the permissible rating will be exceeded.

This is even more cogent as the varistors have a negative temperature coefficient, which means that at a higher dissipation (and accordingly at a higher temperature) the resistance value will decrease and the dissipated power will increase further.

AC DISSIPATION

When a sinusoidal alternating voltage is applied to a varistor, the dissipation cannot be calculated from the same formula as in a DC application. The calculation requires an integration of the $V \times I$ product.

The instantaneous dissipated power is given by:

$$P_{\text{INST}} = V \times I = V (K \times V^{\alpha}) = K \times V^{\alpha+1}$$

In the above equation, the value $V = V_{\text{peak}} \times \sin \omega t$.

During a half cycle, the dissipated power is given by:

$$P_{\text{RMS}} = \frac{1}{\pi} \int_0^{\pi} K \times V_{\text{peak}}^{\alpha+1} \times (\sin \omega t)^{\alpha+1} \times dt$$

Since $V_{\text{peak}} = V_{\text{RMS}} \times \sqrt{2}$

$$P_{\text{RMS}} = \frac{1}{\pi} \times K \times V_{\text{RMS}}^{\alpha+1} \times (\sqrt{2})^{\alpha+1} \times \int_0^{\pi} (\sin \omega t)^{\alpha+1} \times dt$$

This integration is not easy to solve because of the exponent ($\alpha + 1$) of $\sin \omega t$.



It is generally easier to use the quotient of the AC power on the DC power:

$$P = P_{AC}/P_{DC}$$

This quotient depends only on the value of α and not more on the K value as shown in the formula:

$$P = \frac{\frac{1}{\pi} \times K \times V_{rms}^{\alpha+1} \times 2^{(a+1)/2} \times \int_0^{\pi} (\sin \omega t)^{\alpha+1} \times dt}{K \times V^{\alpha+1}}$$

$$P = \frac{1}{\pi} \times 2^{(a+1)/2} \times \int_0^{\pi} (\sin \omega t)^{\alpha+1} \times dt$$

P has been calculated by successive application of a reduction formula; see Power Ratios table.

POWER RATIOS									
α	P	α	P	α	P	α	P	α	P
1	1.0	11	14.4	21	344	31	9135	41	255 646
2	1.2	12	19.6	22	477	32	12 776	42	358 778
3	1.5	13	26.8	23	658	33	17 734	43	499 673
4	1.92	14	36.7	24	915	34	24 822	44	701 611
5	2.5	15	50.3	25	1264	35	34 482	45	977 622
6	3.29	16	69	26	1763	36	48 301	46	1 373 365
7	4.375	17	95	27	2439	37	67 149	47	1 914 510
8	5.85	18	131	28	3404	38	94 126	48	2 690 675
9	7.875	19	180	29	4715	39	130 941	49	3 752 439
10	10.64	20	249	30	6587	40	183 660	50	5 275 834

TEMPERATURE COEFFICIENT

In the leakage current region of the V/I characteristic, the normal equation $V = C \times I^\beta$ of the varistor becomes less applicable.

This is due to a parallel resistance which shows a very important temperature coefficient, created by thermal conduction. This temperature coefficient decreases when the current density increases. Then, the temperature coefficient at 1 mA is higher for a large varistor than for a small varistor.

This phenomena induces an increase in leakage current when the varistor is used at high temperatures. The relationship between the temperature and the current at a given voltage can be expressed by:

$$I = I_0 \times e^{KT}$$

where:

I_0 is the limiting current at 0 Kelvin

K is a constant including the band gap energy of the zinc oxide and the Boltzmann's constant.

Practically, the maximum temperature coefficient is guaranteed on the voltage for a current of 1 mA in % per K.

SURGE PROTECTION

Varistors provide protection against surges which may be generated in the following ways:

ELECTROMAGNETIC ENERGY

Atmospheric, lightning

Switching of inductive loads:

- Relays
- Pumps
- Actuators
- Spot welders
- Thermostats
- Fluorescent chokes
- Discharge lamps
- Motors
- Transformers
- Air conditioning units
- Fuses

ELECTROSTATIC DISCHARGES

For example, discharges caused by synthetic carpets (approximately 50 kV), due to the inductance of the connecting leadwires, the reaction time of leaded VDR's might be too slow to clamp properly fast rising ESD pulses.

SOURCE OF TRANSIENT

The energy dissipated by switching of an inductive load is completely transferred into the capacitance of the coil which is generally very low.

$$E = \frac{1}{2} \times L \times I^2 = \frac{1}{2} \times C \times V^2$$

Examples, using the following values:

Mains voltage = 220 V_{RMS};
 allowable peak voltage = 340 V
 Line inductance: L = 20 μH = 20 x 10⁻⁶ H
 Line capacitance: C = 300 nF = 0.3 x 10⁻⁶ F
 Line resistance: 0.68 Ω

In the event of a short circuit:

$$\text{Load current: } I_L = \frac{V}{R} = \frac{340 \text{ V}}{0.68 \text{ } \Omega} = 500 \text{ A}$$

$$\text{Energy stored: } E = \frac{1}{2} \times 20 \times 10^{-6} \times 25 \times 10^4 = 2.5 \text{ J (Ws)}$$

In the event of a fuse going open circuit:

The energy goes from inductance L towards line capacitance:

$$V_C = \sqrt{\frac{2E}{C}} = \sqrt{\frac{2 \times 2.5}{0.3 \times 10^{-6}}} = 4082 \text{ V}$$

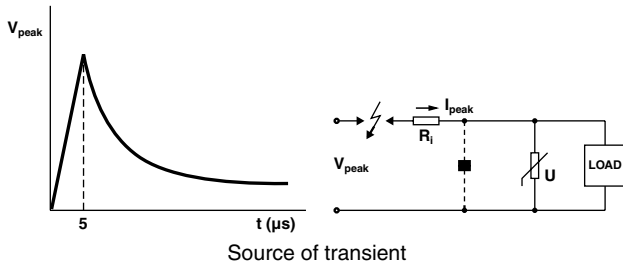

The line impedance becomes high when the fuse goes open circuit (resistance against high voltage peak in a very short time).

$$R_i = \omega L = 2 \pi f L$$

Since the rise time of the pulse is 5 μs, the frequency f = 50 kHz.

$$R_i = 6.28 \text{ } \Omega \times 50 \times 10^3 \times 20 \times 10^{-6} = 6.28 \text{ } \Omega$$

$$Z_i = 6.28 \text{ } \Omega + 0.68 \text{ } \Omega = 6.96 \text{ } \Omega$$

$$V_{Ri} = 6.96 \text{ V} \times 500 \text{ A} = 3480 \text{ V}$$

$$V_{VDR} = 4082 \text{ V} - 3480 \text{ V} = 602 \text{ V}$$

VARISTOR APPLICATIONS

Varistors may be used in many applications, including:

- Computers
- Timers
- Amplifiers
- Oscilloscopes
- Medical analysis equipment
- Street lighting
- Tuners
- Televisions
- Controllers
- Industrial power plants
- Telecommunications
- Automotive
- Gas and petrol appliances
- Electronic home appliances
- Relays
- Broadcasting
- Traffic facilities
- Electromagnetic valves
- Railway distribution/vehicles
- Agriculture
- Power supplies
- Line ground (earth protection)
- Microwave ovens
- Toys, etc.

APPLICATION EXAMPLES

For suppression of mains-borne transients in domestic appliances and industrial equipment, see Suppression via load, Suppression directly across mains, Switched-mode power supply protection and Protection of a thyristor bridge in a washing machine drawings.

Type 2381 592 or 2381 593

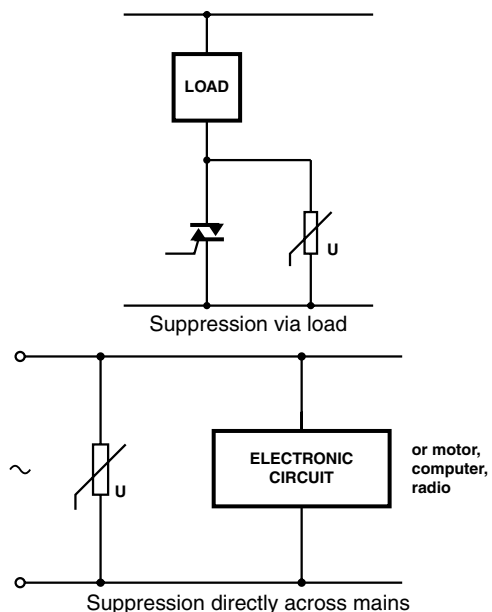

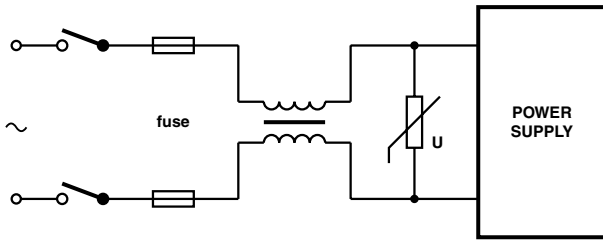

Switched-mode power supply protection

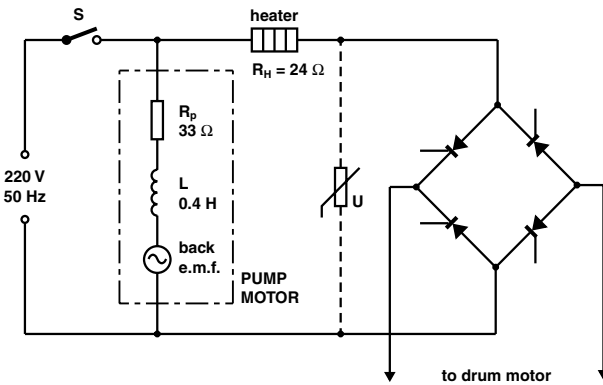

Protection of a thyristor bridge in a washing machine

BEHAVIOUR OF THE CIRCUIT WITHOUT VARISTOR PROTECTION

The measured peak current through the pump motor when S is closed is 1 A (see protection of a thyristor bridge in a washing machine drawing). The energy expended in establishing the electromagnetic field in the inductance of the motor is therefore:

$$I^2 \times \frac{L}{2} = \frac{0.4}{2} = 200 \text{ mJ}$$

Without varistor protection, an initial current of 1 A will flow through the thyristor bridge when S is opened, and a voltage sufficient to damage or destroy the thyristors will be developed. Arching will occur across the opening contacts of the switch.

BEHAVIOUR OF THE CIRCUIT WITH VARISTOR 2381 593 52516 INSERTED

On opening switch S, the peak voltage developed across the varistor is: $V = C_{max} \times I^{\beta} = 600 \text{ V}$

The thyristors in the bridge can withstand this voltage without damage.

The total energy returned to the circuit is 200 mJ. Of this 200 mJ, 15.1 mJ is dissipated in the heater, and 184.3 mJ is dissipated in the varistor. The varistor can withstand more than 10^5 transients containing this amount of energy.

For suppression of internally generated spikes in electronic circuits, see Varistor used across a transistor or coil in a television circuit and Varistor used across a switch or coil drawings.

In both examples shown in the drawings Varistor used across a transistor or coil in a television circuit and Varistor used across a switch or coil, type 2381 592 should be used for up to approximately 50 A, and type 2381 593 up to approximately 120 A.

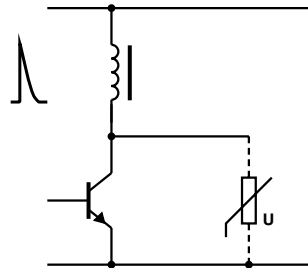

Varistor used across a transistor or coil in a television circuit

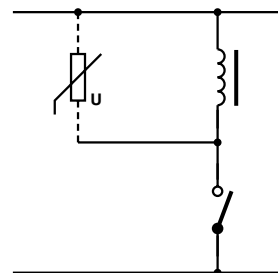

Varistor used across a switch or coil

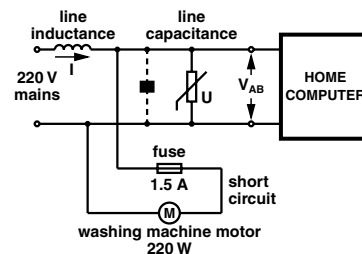
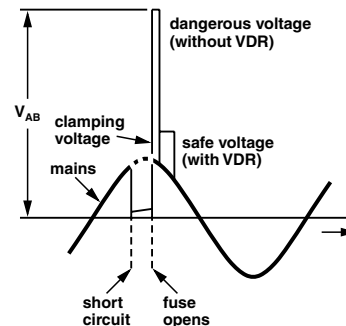

Influence of a transient on the mains voltage



SELECTION OF THE CORRECT VARISTOR TYPE

In order to select a ZnO varistor for a specific application, the following points must first be considered:

1. The normal operating conditions of the apparatus or system, AC or DC voltage?
2. What is the maximum RMS or DC voltage?

To ensure correct selection of varistor type, two multi choice selection charts have been prepared, see charts below.

The first chart determines the necessary steady state voltage rating (i.e. working voltage) and the second chart determines the correct size (i.e. correct energy absorption).

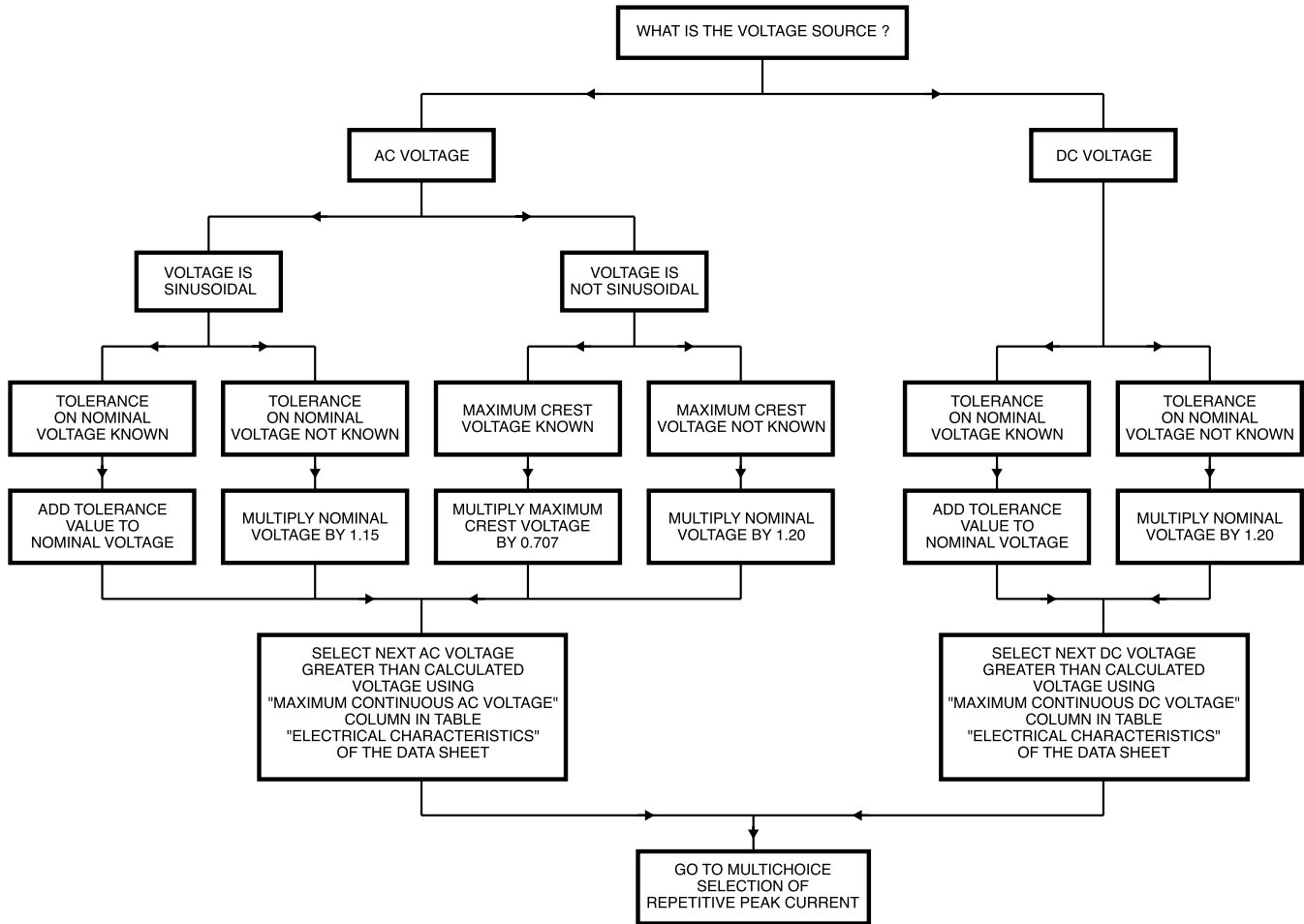

Multi choice selection chart to determine the necessary steady state voltage rating (i.e. working voltage)

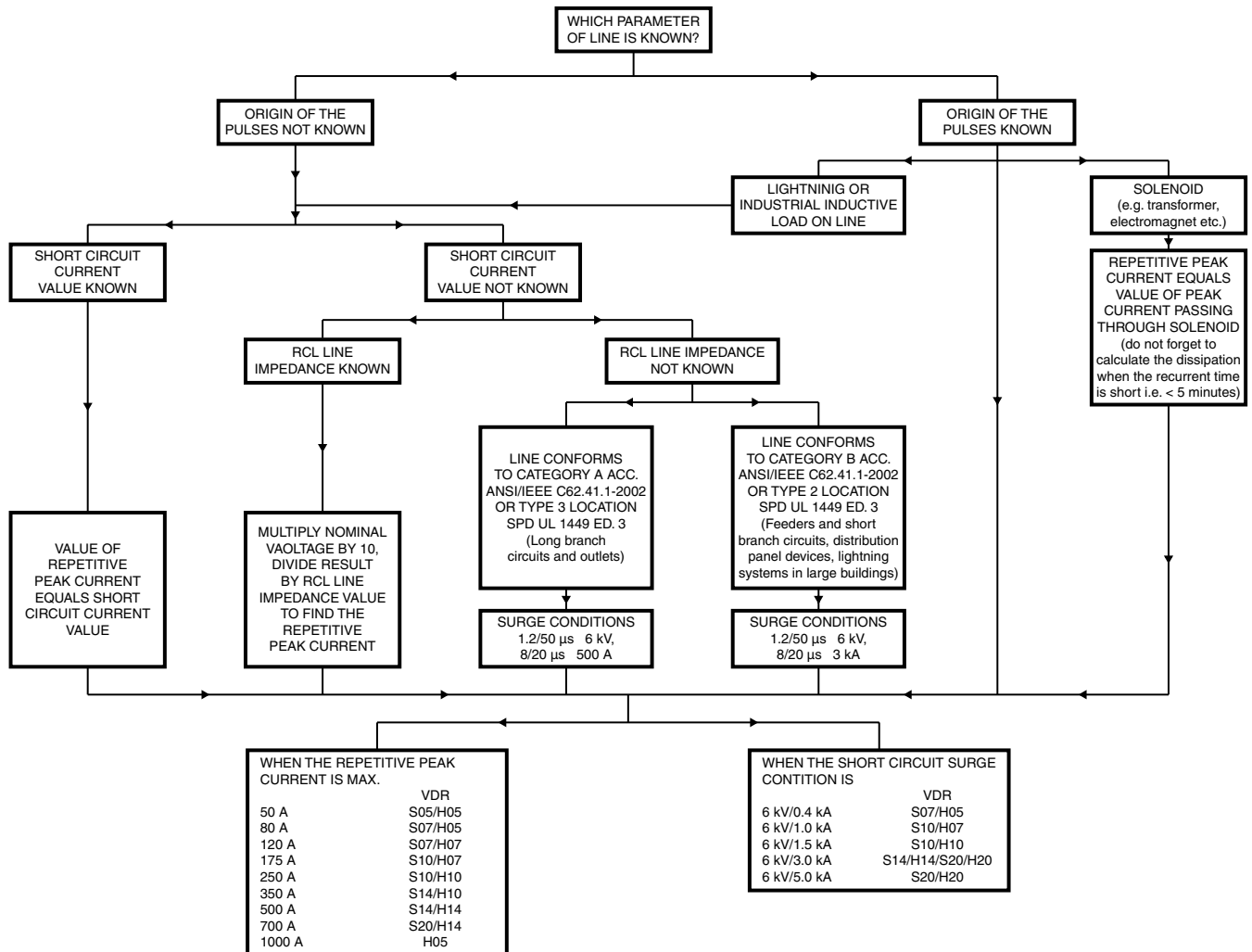

Multi choice selection chart to determine the correct size (i.e. correct energy absorption)